

Duplo

from print to documents

Duplo

DuBinder DPB-500
Product Presentation

Duplo

Features and Benefits

Touch Screen

- The DPB-500 is equipped with user friendly Touch Screen control panel.
- It host features such as
 - A) Job memories
 - B) Fine adjustments
 - C) Glue cut off
 - D) Weekly timer

Touch Screen control



20 job memories



Fine adjustment by 0.1mm steps



Double Detection for covers

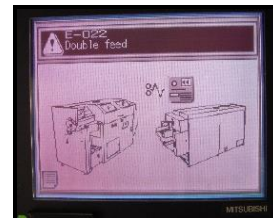

Incorrect book sensor

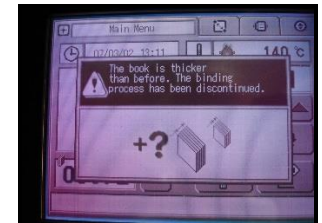

Features and Benefits

Spine Preparation

- The DPB-500 is equipped with heavy duty milling and notching unit.
- It is retractable and the height can be adjusted from 0mm to 4mm
- It can produce books from
 - A) single sheets
 - B) Folded sections

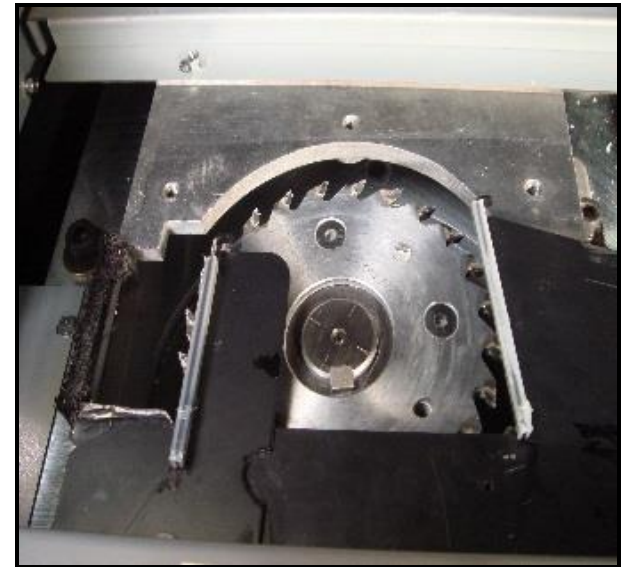

Features and Benefits

Gluing technology

- The DPB-500 is equipped with an open tank technology
- 2 Glue drums for precise spine gluing
- Auto doctor blades: To remove excess glue
- Auto side gluing

All the adjustments are done **automatically**



Features and Benefits

Auto book block measurement

- The machine automatically measures the thickness on the book block and adjust all the parameters on the machine

**Automatic
set up for
each book
thickness up
to 51mm**

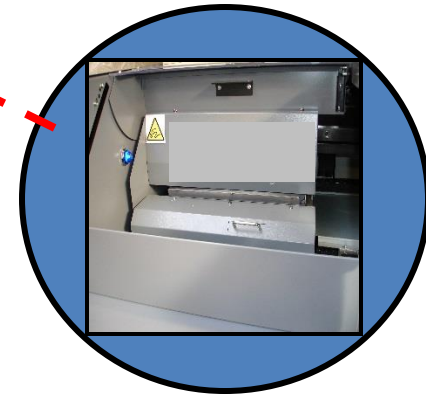

- The machine is equipped with two modes
 - A) The DPB 500 measures the thickness of each and every book
 - B) The DPB-500 measures the thickness of the first book and then run at full speed. It only stops if there is in-correct book block.

Only the correct book can be bound!

No wastage of covers and expensive re-prints!

Features and Benefits

In-line cover feeding and scoring

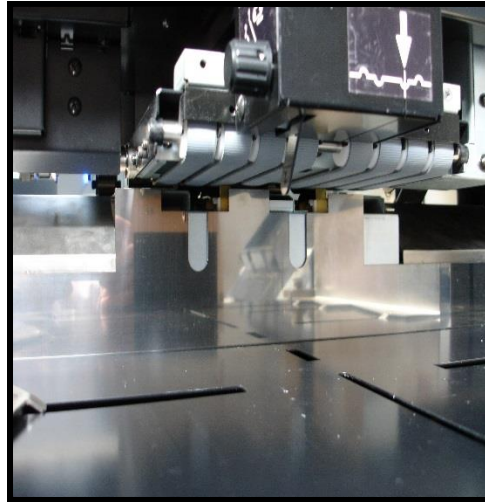

- 8 belt top suction feeding
- **A.M.S.** Duplo's unique "Air Management System". For accurate and mark free feeding of covers.
- Equipped with double cover feed detection.

Features and Benefits

Timer



Weekly/Daily timer

- More productivity gained of 50-60 mins = 500 books

Optional Features

Wing Score

- The DPB-500 can produce books of 6 or 8 pages cover by adding optional wing score.

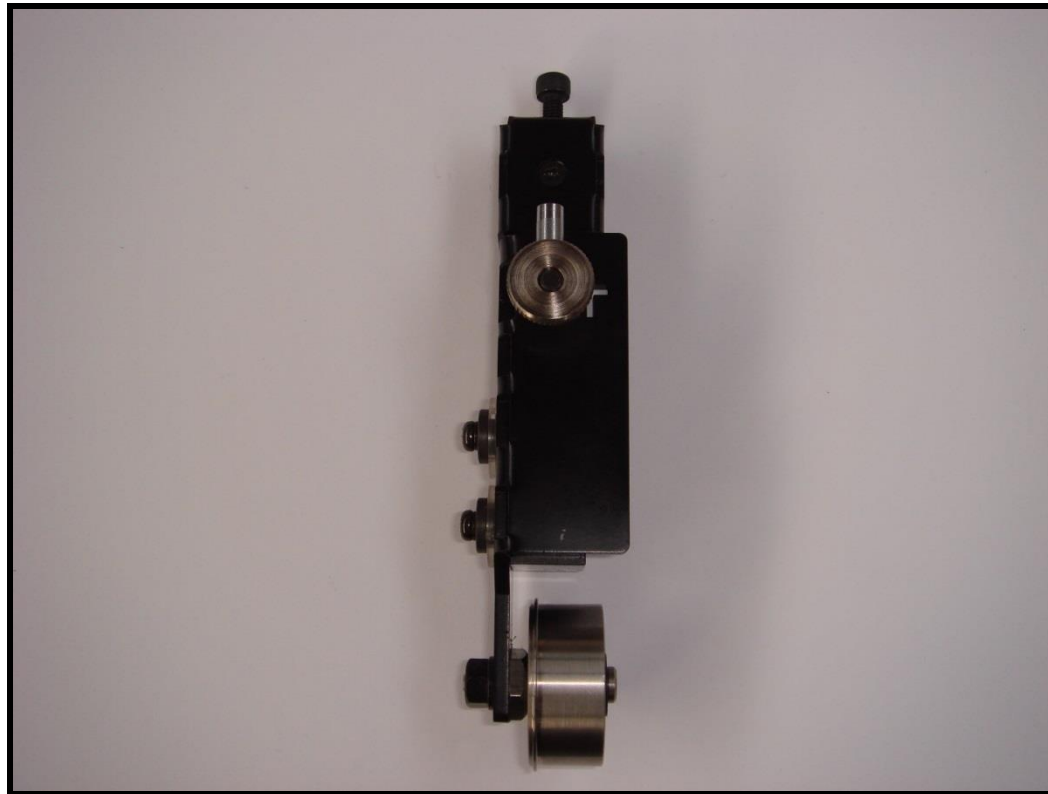

Long Conveyor

The DPB-500 can be equipped with the long conveyor for interpreted production

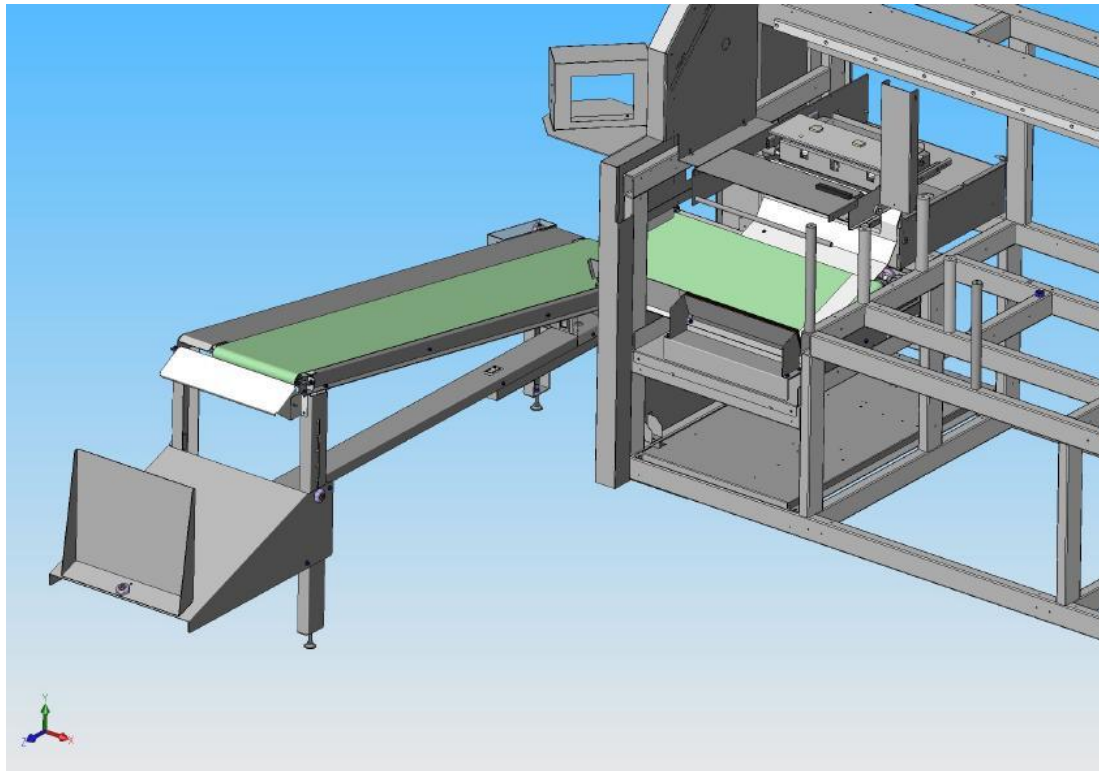

Barcode Reader

1. The book is scanned by the barcode reader in the clamp (Book ID for matching function and rest of digit for auto paper size setting).

- 2 Place the book in clamp.
Then the thickness will be measured and set-up all book parameters automatically.

3. The barcode on the cover is read for matching function before feeding.

4. After confirming the matching between book and cover, cover will be fed to the nipping section.

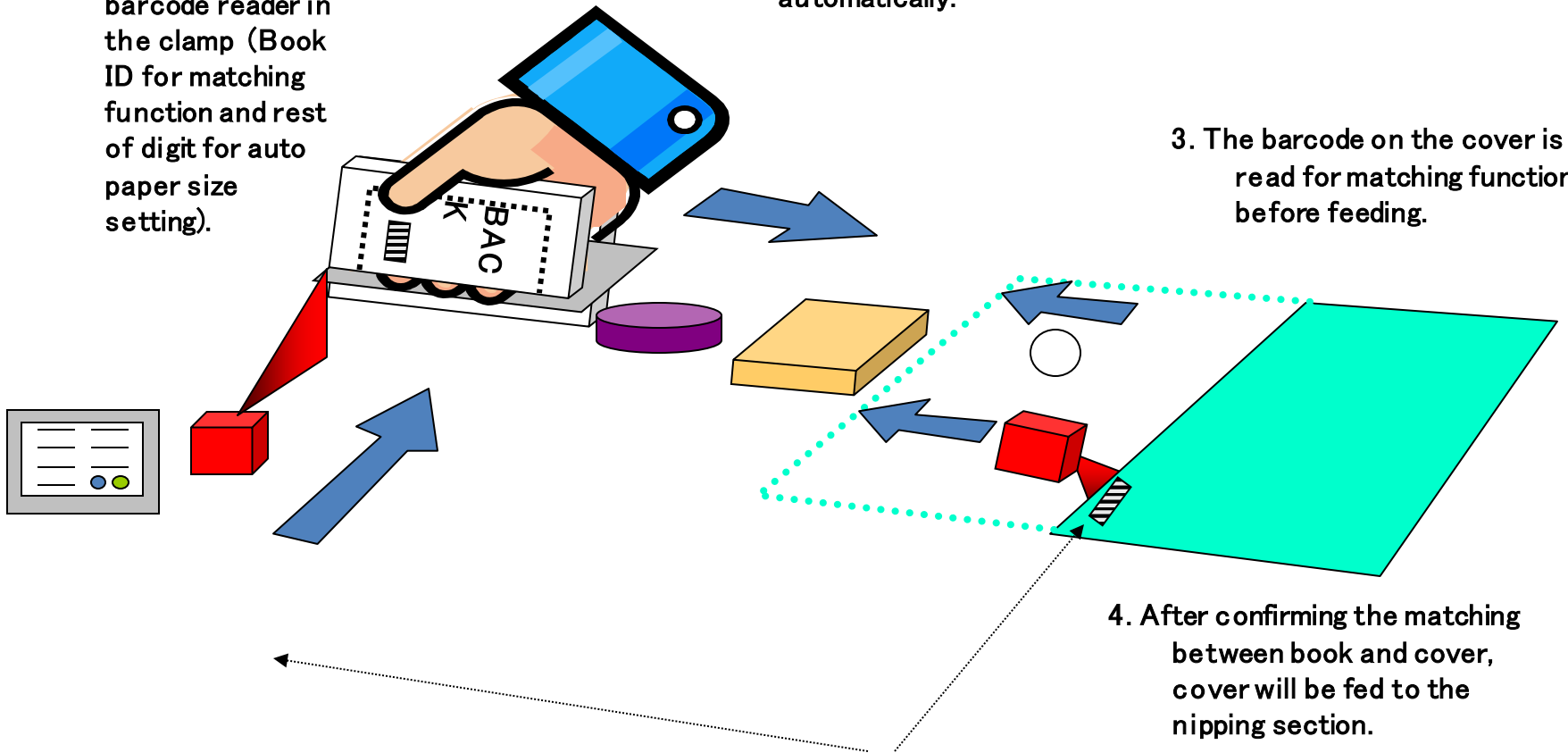

Why should a printer invest
in a DuBinder DPB-500 ?

Investment opportunities

- **Increase in demand** – Productive easy to operate machine. Auto operation, No need for separate creasing machine. No requirement for skilled bindery operator.
- **Printers sending work out** – Bring jobs back in house+ increase their binding publications and their printed output.
- **Faster turn around of work** > retain more profit
UK customer(RPM) monthly cost savings of **£900.00 (previously sending work out)**
- **Low consumable cost** 20KG bag of glue cost £115.00
5,000 A4bks (10mm spine) = .02p or .03euro per book
- **Finish-** demand for a quality spine-titled book

Target Customers

Target Customers

- Mid - High volume of books app 1000-2000 books per day
- Printers producing both litho and digital jobs
- Digital customers who require small runs, but with a quick set up time
- The requirement for accurate registration – Spine titles
- The need to produce work on high quality stocks and covers
- The ability to crease/bind the covers in one pass
- The print finisher who relies on a fast turnaround
- Printers that are producing folded section books where the spine has to be removed or (milled) prior to gluing